

DEDE

Art.-Nr.

305 840
305 843
305 845

1100
745
500
mm

1/6
VO



40 min

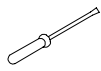

PZ2



0,5 kg







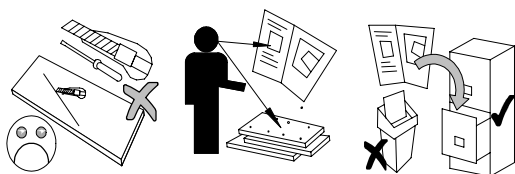
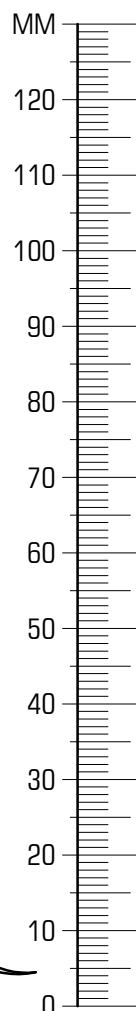
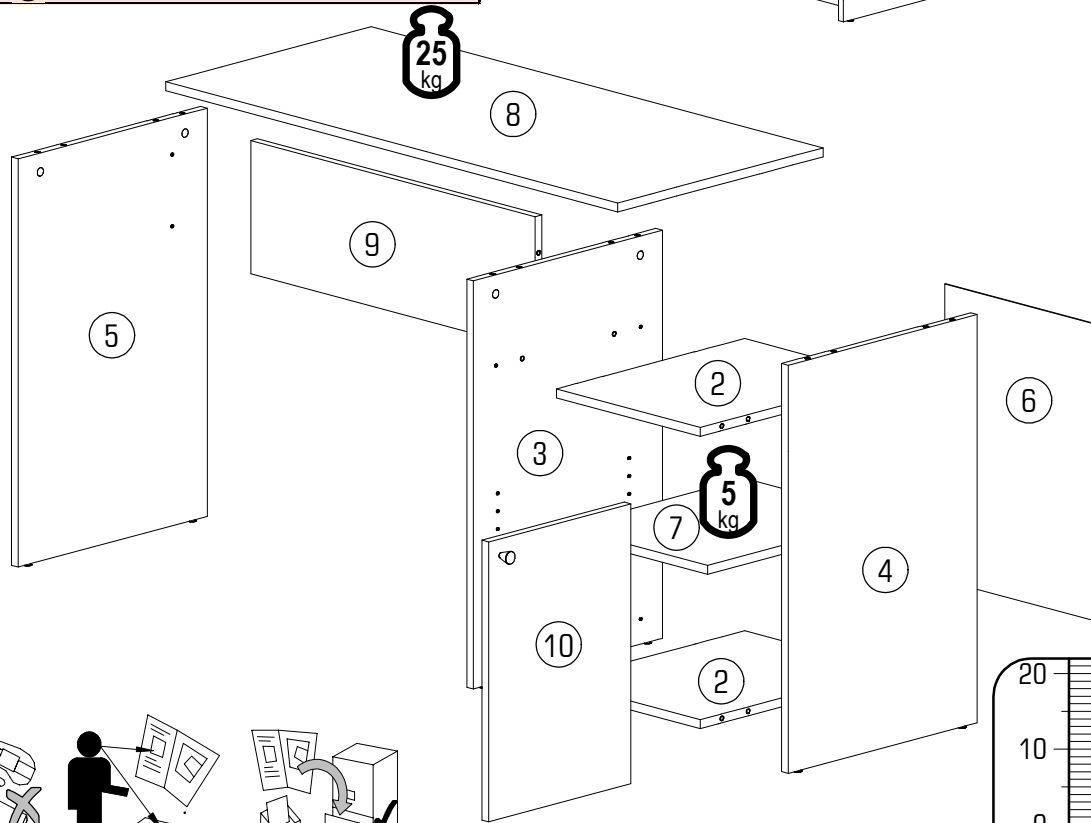
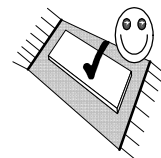
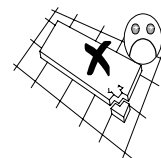
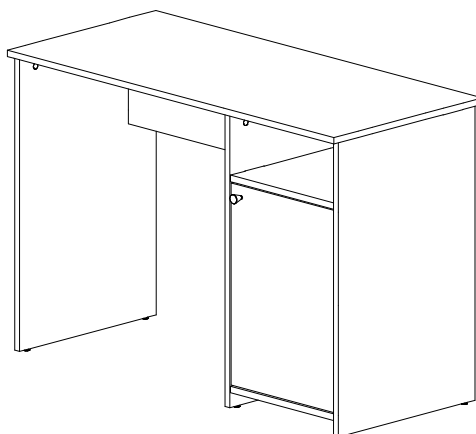

3m

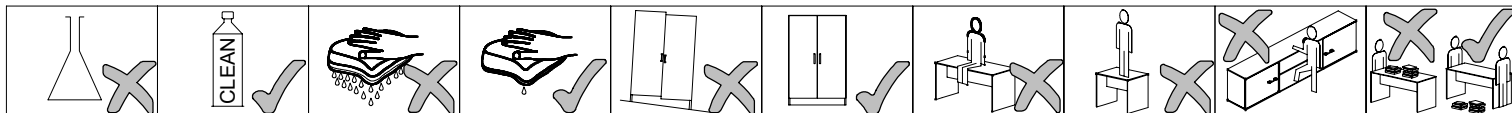
ID.EE	ID	Icon	Dimensions	Quantity	Ratio
18469	②		350*458*16	2x	1/1
18472	③		729*460*16	1x	1/1
18473	④		729*460*16	1x	1/1
18470	⑤		729*460*16	1x	1/1
18471	⑥		530*376*3	1x	1/1
18474	⑦		350*440*16	1x	1/1
18475	⑧		1100*500*16	1x	1/1
18476	⑨		692*238*16	1x	1/1
18477	⑩		500*346*16	1x	1/1

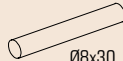

A 10x	B 25x	C 4x	D 1x	E 14x	F 6x	G 4x	H 18x
J 18x	K 1x	L 2x	M 2x				

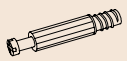

					
E 14x	F 6x	G 4x	H 18x	J 18x	M 2x

